

PRODUCT SPECIFICATIONS

Halsey Taylor Outdoor Cast Iron Fountain Non-Filtered Non-Refrigerated Forest Green. Furnished with Push Button bubbler. Mechanical Top Bubbler Button activation. Product shall be Floor Mount/Freestanding, for Outdoor applications, serving 1 station(s). Unit shall be lead-free design which is certified to NSF/ANSI 61 & 372 (lead free) and meets Federal and State low-lead requirements.



Order ID:	74045212180
Finish:	Forest Green
Power:	No Electrical Required
Bubbler Style:	Push Button
Activation by:	Mechanical Top Bubbler Button
Mounting Type:	Floor Mount/Freestanding
Chilling Capacity:	Non-refrigerated
Dimensions (L x W x H):	14" x 14" x 39-1/4"
Approx. Shipping Weight:	62 lbs.
Installation Location:	Outdoor
No. of Stations Served:	1

**When used in non-temperature controlled environments, unit(s) must be adequately winterized and/or protected from extreme heat to prevent damage where climates dictate.

- Mechanically-Activated bubbler continues to supply water in event of service disruptions.

Included with Product: Outdoor Fountain
Ships in one box.

AMERICAN PRIDE. A LIFETIME TRADITION. Like your family, the Elkay family has values and traditions that endure. For almost a century, Elkay has been a family-owned and operated company, providing thousands of jobs that support our families and communities.



PRODUCT COMPLIANCE

ASME A112.19.3/CSA B45.4

Buy American Act

NSF/ANSI 61 & 372 (lead free)



[Installation Instructions \(PDF\)](#)

Warranty pertains to drinking water applications only. Non-drinking water applications are not covered under warranty.

[Warranty \(PDF\)](#)

PART: _____ QTY: _____

PROJECT: _____

CONTACT: _____

DATE: _____

NOTES: _____

APPROVAL: _____

In keeping with our policy of continuing product improvement, Halsey Taylor reserves the right to change product specifications without notice. Please visit Halseytaylor.com for the most current version of Halsey Taylor product specification sheets. This specification describes a Halsey Taylor product with design, quality, and functional benefits to the user. When making a comparison of other producers' offerings, be certain these features are not overlooked.

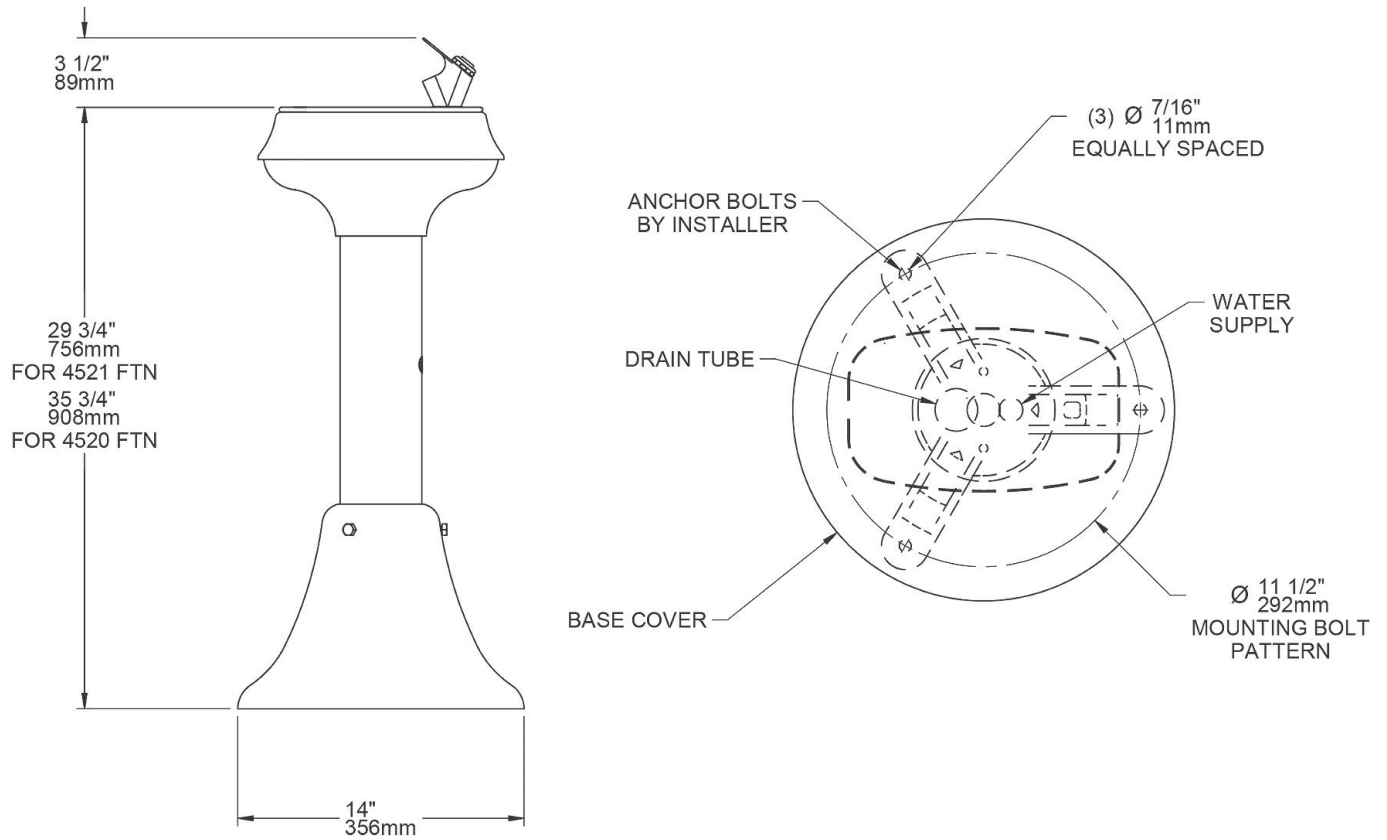

In keeping with our policy of continuing product improvement, Halsey Taylor reserves the right to change product specifications without notice. Please visit Halseytaylor.com for the most current version of Halsey Taylor product specification sheets. This specification describes a Halsey Taylor product with design, quality, and functional benefits to the user. When making a comparison of other producers' offerings, be certain these features are not overlooked.